

Coaxial Isolator IC 2.4-5W

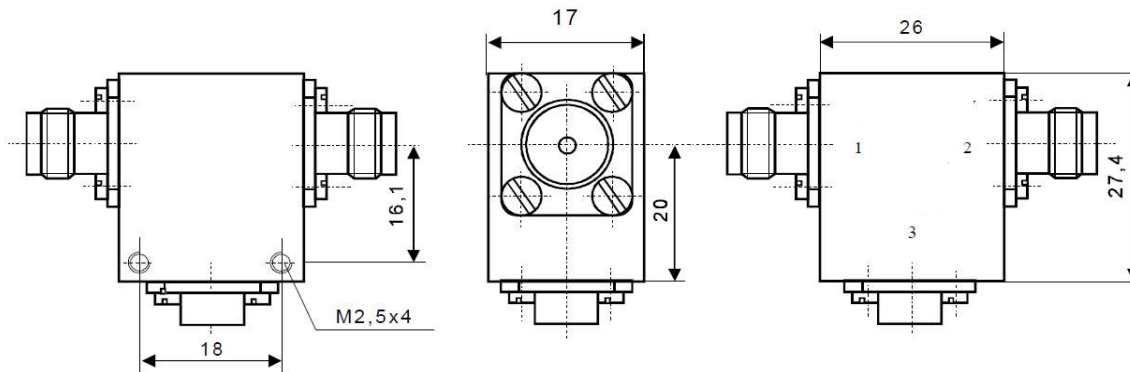

Electrical Specifications

	Min	Max	Unit
Operating Frequency	2,2	2,6	GHz
Insertion Loss		0,4	dB
Isolation	20		dB
VSWR		1,25	
Forward Power		10	W
Reverse Power		5	W

Mechanical Specifications

Interface/ Connectors	SMA -
Direction	CW
Weight	60 g
Housing Material	AlMgSi; Steel
Surface	Conversion Coating; Ni-coated

Environmental Specifications

Operating Temp. Range (°C)	-10	+65
----------------------------	-----	-----