

## Coaxial Isolator IC 6.8 aat

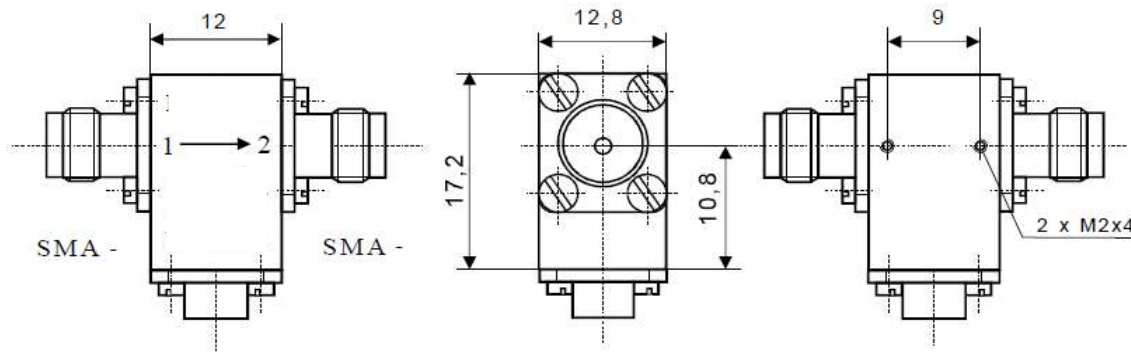

### Electrical Specifications

	Min	Max	Unit
Operating Frequency	6,75	6,85	GHz
Insertion Loss		0,25	dB
Isolation	23		dB
VSWR		1,2:1	
Forward Power		1	W
Reverse Power		1	W

### Mechanical Specifications

Interface/ Connectors	SMA -
Direction	CW
Weight	25 g
Housing Material	AlMgSi; Steel
Surface	Conversion Coating; Ni-coated

### Environmental Specifications

Operating Temp. Range (°C)	-10	+65
----------------------------	-----	-----