

Waveguide Isolator

IFW 14.65 v.6

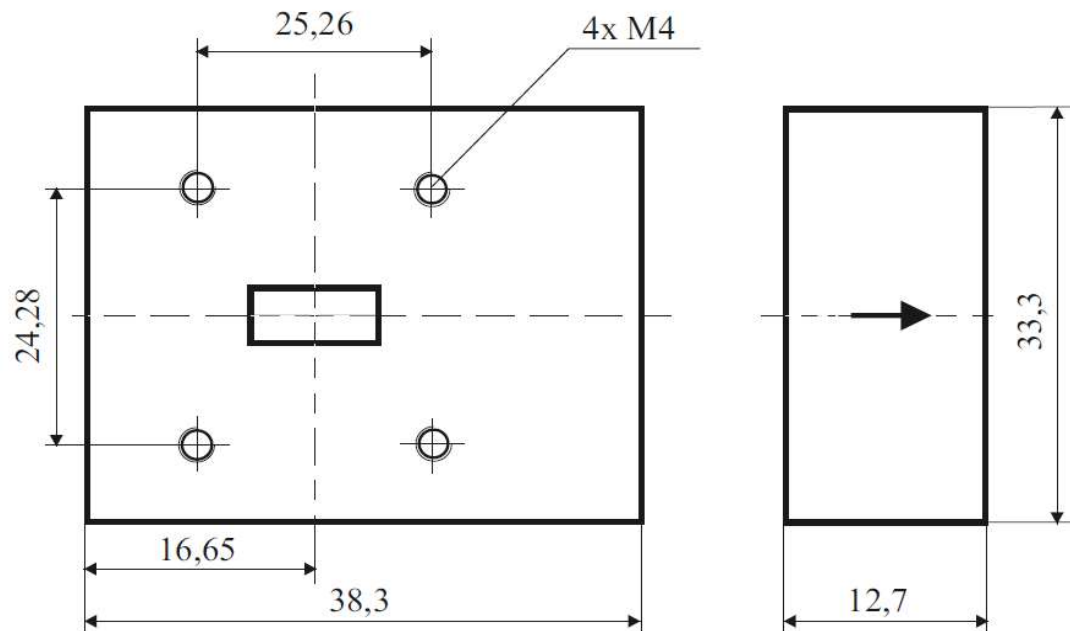

Electrical Specifications

	Min	Max	Unit
Operating Frequency	14,3	15	GHz
Insertion Loss		0,4	dB
Isolation	18		dB
VSWR		1,29	
Forward Power		1	W
Reverse Power		1	W

Mechanical Specifications

Interface/ Connectors	WR 62/	UBR 140
Direction	marked on the device	
Weight	60 g	
Housing Material	AlMgSi; Steel	
Surface	Conversion Coating; Ni-coated	

Environmental Specifications

Operating Temp. Range (°C)	-40	+80
----------------------------	-----	-----